

ST 100 Stacking Tower

The shoring system with only one frame size for all heights

Product Brochure – Edition 09/2017

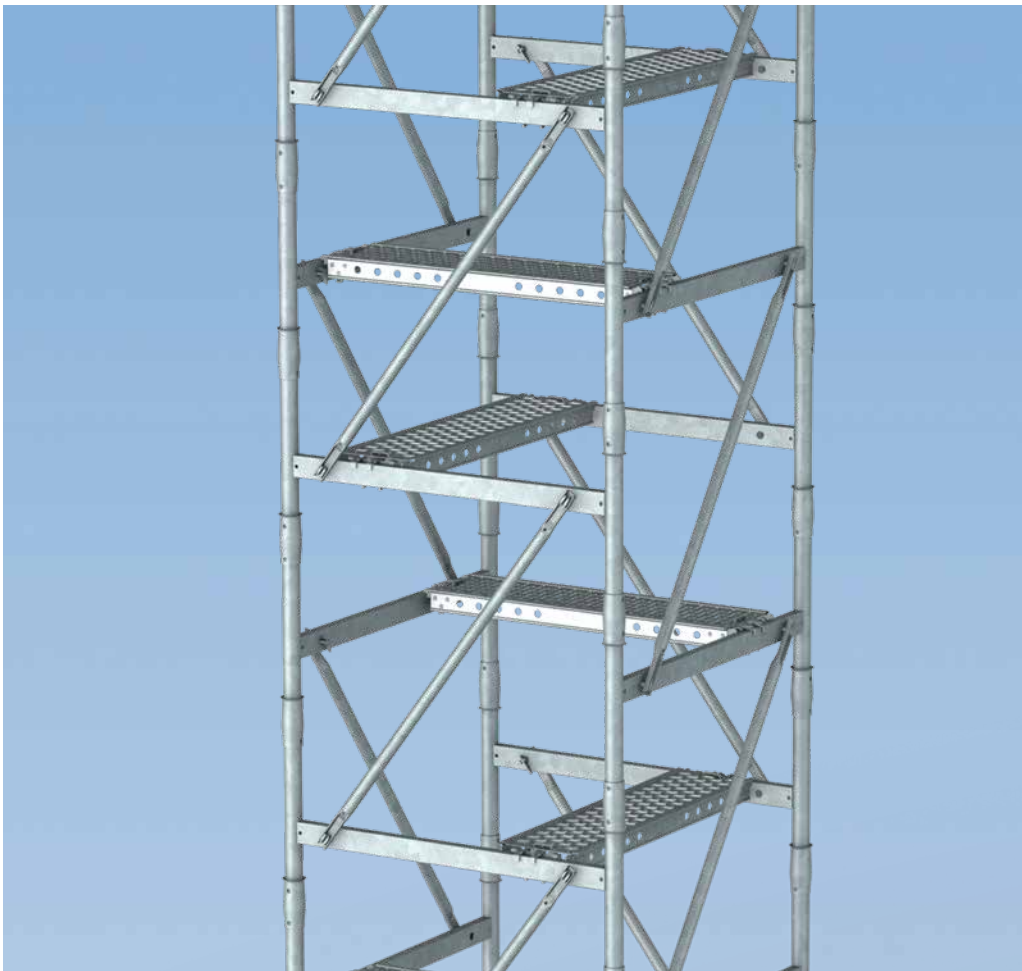

Content

System advantages		System overview	
5	The shoring system with only one frame size for all heights	12	The ST 100 Stacking Tower at a glance
6	Extremely easy handling and logistics	Standard applications	
8	Fast assembly	14	Execution details
10	Minimum of planning		

Edition 09/2017

Publisher

PERI GmbH
Formwork Scaffolding Engineering
Rudolf-Diesel-Strasse 19
89264 Weissenhorn
Germany
Phone +49 (0)7309.950-0
Fax +49 (0)7309.951-0
info@peri.de
www.peri.de

Project examples

16 ST 100 Stacking Tower in use

Components

18 ST 100 Stacking Tower

Important information

All current safety regulations and guidelines applicable in those countries where our products are used must be observed.

The photos shown in this brochure feature construction sites in progress. For this reason, safety and anchor details in particular cannot always be considered as conclusive or final. These are subject to the risk assessment carried out by the contractor.

In addition, computer graphics are used which are to be understood as system representations. For ensuring a better understanding, these and the detailed illustrations shown have been partially re-

duced to show certain aspects. The safety installations which have possibly not been shown in these detailed descriptions must nevertheless still be available. The systems or items shown might not be available in every country.

Safety instructions and load specifications are to be strictly observed at all times. Separate structural calculations are required for any deviations from the standard design data.

The information contained herein is subject to technical changes in the interests of progress. Errors and typographical mistakes reserved.



ST 100 Stacking Tower

The shoring system with only one frame size for all heights

The ST 100 Stacking Tower has been designed for fast assembly and dismantling according to the stacking principle. The individual frames are simply inserted into each other and offset by 90°; tools are not required. With a single frame type, all required assembly heights can be realized. Diagonal bracing ensures extremely tight connections for crane transport and during erection.

With only one frame size – the 50 cm high stacking frame – all heights can be easily assembled and without requiring any time-consuming pre-planning.

A shoring tower with a 1.00 m x 1.00 m ground plan is comprised of 4 stacking frames per m of tower height. The ST 100 is assembled without any small components as connecting bolts or other parts which can easily be lost on the construction site are not required.

Detailed material calculations according to combination tables, corresponding work preparation and time-consuming searches for many different parts are not necessary with the ST 100.

The ST 100 Stacking Tower stands out in particular through its high load-bearing capacity. Leg loads of up to 53 kN

are possible - depending on the tower height and wind load. For an assembly height of 22.29 m, up to 214 kN load per tower is permitted according to the type test. The tower can be used either free-standing or restrained at the top.

Extremely easy handling and logistics

All tower heights can be realized with only 5 system components

Fast assembly

Easy and simple assembly without bolts or pins – without any tools whatsoever

Minimum of planning

With only one frame size and without combination tables, each application height can be easily planned.

Extremely easy handling and logistics

All tower heights can be realized with only 5 system components

The ST 100 requires only 5 system components. This means the PERI Stacking Tower ST 100 can be erected to any height.

Fast height adjustment through the 50 cm grid dimensions of the frames in combination with the convenient spindling range. When selecting a

configuration without diagonal struts, 4 system components suffice. The Base-Head Frame is used as the base and head frame respectively. 4 stacking frames result in one metre of height. The number of required diagonals for the ST 100 depends on the static system being applied. Head and base spindles are equipped with captive Quick Jack Nuts.

Regardless whether it is residential, industrial or bridge construction, the PERI Stacking Tower ST 100 carries a load of up to 214.0 kN per tower according to the type test.



The stacking frame weighs less than 7 kg which facilitates ergonomic and fast assembly.



Regardless whether for high or low assembly – the PERI ST 100 is suitable for use everywhere.



Even without diagonals, the PERI Stacking Tower is capable of carrying loads. (Take type test into consideration).



With the ST 100, heavy beams can be concreted in advance. This can be done very quickly as the ST 100 very often does not require any diagonals.



Safe and reliable transfer of very high loads also from great heights.



For larger heights, the ST 100 is horizontally pre-assembled. The diagonal bracing ensures the structure is tightly connected for transport with the crane.

Fast assembly

Easy and simple assembly without bolts or pins – without any tools whatsoever

The ST 100 is quickly assembled. Everything on the ST 100 is simply slotted together. No bolts or pins required. Without any other components which can easily be lost on the construction site. No additional tools are required.



The Diagonal Brace ST 100 has a finger at one end and a gravity pin at the other. This means assembly can take place very quickly.



The PERI Stacking Tower ST 100 is simply slotted together.



To set up the Base-Head Frame adjust base spindles to required height and level accordingly.



Install required number of stacking frames.



Mount head frame.



Adjust the head spindles to the required size and insert.

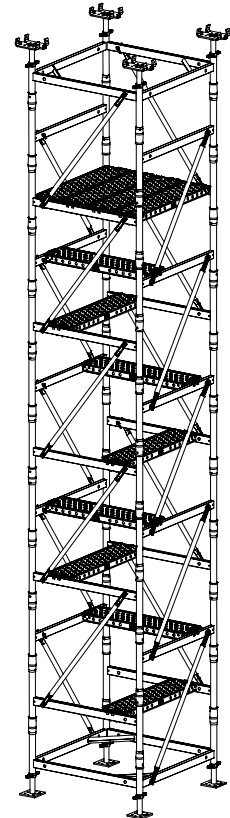

Safe access and working areas are created with the Industrial Decking UDG 25 x 100. Individual decks are quickly and easily installed.



For large heights, it can be more cost-effective to assemble the stacking tower in a horizontal position. In this case, diagonal bracing must be used in order to ensure that the ST 100 is connected tightly enough for transport by crane.

Practical tip:

During horizontal assembly, the bottom diagonal bracing is always fixed immediately to the stacking frame.

Minimum of planning

With only one frame size and without combination tables, each application height can be easily planned.

With only one frame size, planning operations for the ST 100 are quickly realized. This means that every working height is simple to plan and organize, without requiring any combination tables.

How many components for the respective tower height?

With this simple calculation process, you can quickly determine how many stacking frames are required for one tower:

Example:

The height of the tower is 5.90 m.
 $(5.90 - 0.81) \times 4 = 20.36$
 So you need 20 stacking frames.

- Number of Base-Head Frames = always 2
- Number of Base Spindles = always 4
- Number of Head Spindles = always 4
- Number of Diagonal Braces = always the same number as the stacking frames – in our example, 20 pieces.

Which spindle extension is correct?

As is the case for all load-bearing scaffold, the following rule also applies to the PERI ST 100:
 First ensure that the Base Spindle is correctly positioned and then begin to assemble.

Example:

The height of the tower is 5.90 m.
 $5.90 - (20 \text{ stacking frames} \times 4) - 0.66$

The remaining height is less than 0.40 m. Therefore, proceed as follows:
 Top spindle extension = 0.10 m.
 Bottom spindle extension
 $0.24 \text{ m} - 0.10 \text{ m} = 0.14 \text{ m}$

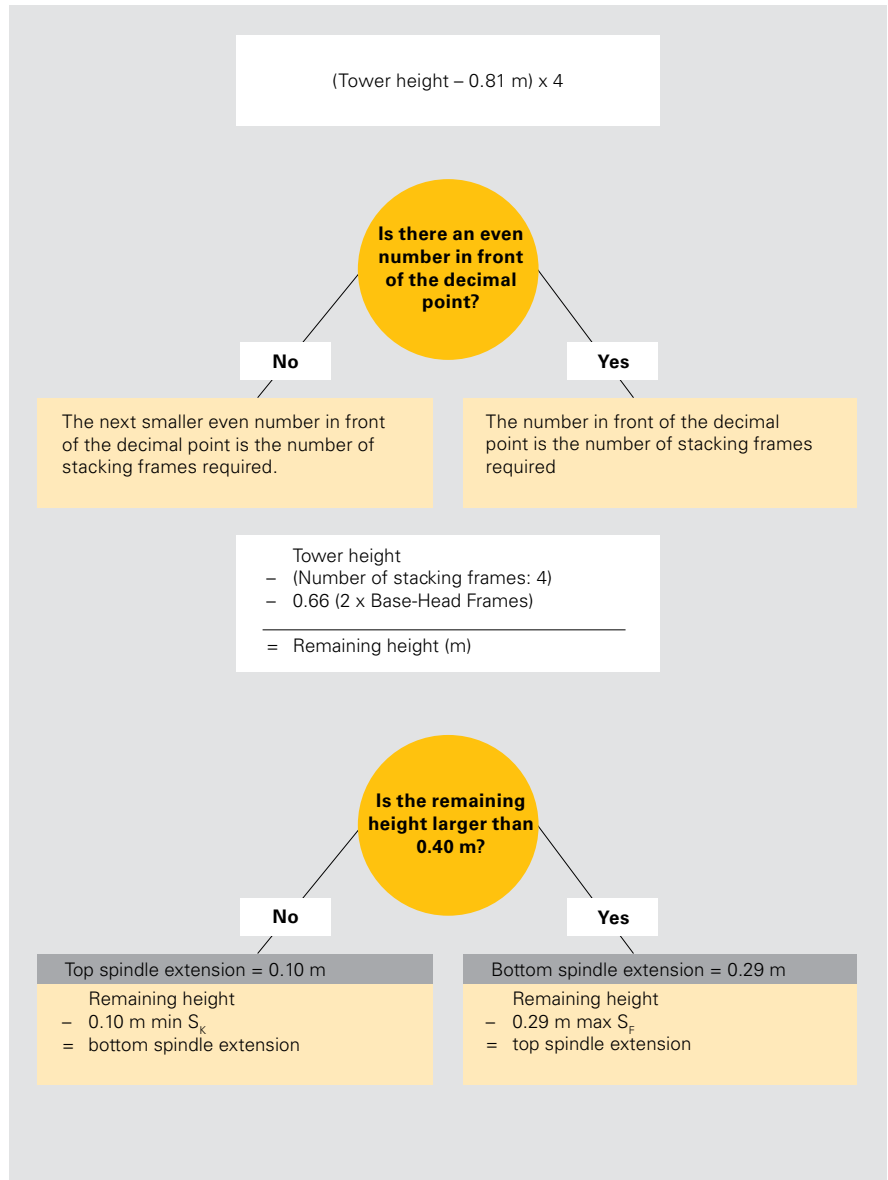

ST 100 Stacking Tower configurator

With the web-based configurator, you can easily, quickly and accurately determine the permissible leg loads as well as the minimum load against sliding.



The tool facilitates the selection of an extensive range of configurations for the a free-standing shoring tower or a shoring tower restrained at the top, various head spindle types, along with taking wind effects on the shoring into consideration and the use of diagonals. After entering the parameters, the

individual result is sent in the form of a PDF. This app provides solutions for tower heights between 1.80 m and 22.29 m. The results are based on Type Test TP-12-004 from the German Institute for Building Technology (DIBt) and the performance data from PERI.



All questions regarding the use of the web-based application can be sent by email to the following address: apps-tools.service@peri.de

Required individual components for ST 100 tower heights from 1.80 up to 22.29 m

Tower height (m) min. – max.	Stacking Frame	Diagonal bracing (if required)	Weight (kg) with diagonal bracing	Weight (kg) without diagonal bracing
1.80 – 2.29	4	4	121.50	112.38
2.30 – 2.79	6	6	139.70	126.02
2.80 – 3.29	8	8	157.90	139.66
3.30 – 3.79	10	10	176.10	153.30
3.80 – 4.29	12	12	194.30	166.94
4.30 – 4.79	14	14	212.50	180.58
4.80 – 5.29	16	16	230.70	194.22
5.30 – 5.79	18	18	248.90	207.86
5.80 – 6.29	20	20	267.10	221.50
6.30 – 6.79	22	22	285.30	235.14
6.80 – 7.29	24	24	303.50	248.78
7.30 – 7.79	26	26	321.70	262.42
7.80 – 8.29	28	28	339.90	276.06
8.30 – 8.79	30	30	368.00	
8.80 – 9.29	32	32	386.20	
9.30 – 9.79	34	34	404.40	
9.80 – 10.29	36	36	422.60	
10.30 – 10.79	38	38	440.80	
10.80 – 11.29	40	40	459.00	
11.30 – 11.79	42	42	477.20	
11.80 – 12.29	44	44	495.40	
12.30 – 12.79	46	46	513.60	
12.80 – 13.29	48	48	531.80	
13.30 – 13.79	50	50	550.00	
13.80 – 14.29	52	52	568.20	
14.30 – 14.79	54	54	586.40	
14.80 – 15.29	56	56	604.60	
15.30 – 15.79	58	58	622.80	
15.80 – 16.29	60	60	641.00	
16.30 – 16.79	62	62	669.10	
16.80 – 17.29	64	64	687.30	
17.30 – 17.79	66	66	705.50	
17.80 – 18.29	68	68	723.70	
18.30 – 18.79	70	70	741.90	
18.80 – 19.29	72	72	760.10	
19.30 – 19.79	74	74	778.30	
19.80 – 20.29	76	76	796.50	
20.30 – 20.79	78	78	814.70	
20.80 – 21.29	80	80	832.90	
21.30 – 21.79	82	82	851.10	
21.80 – 22.29	84	84	869.30	

Basic components for all tower heights:

2 x Base-Head Frame ST 100

4 x Base Spindle TR 38-70/50

4 x Head Spindle TR 38-70/50

or

4 x Cross Forkhead TR 38-70/50

8 x Safety Straps (if required)

Complete tower heights including base and head spindles.

The weight specifications include the Crosshead Spindle TR 38-70/50.

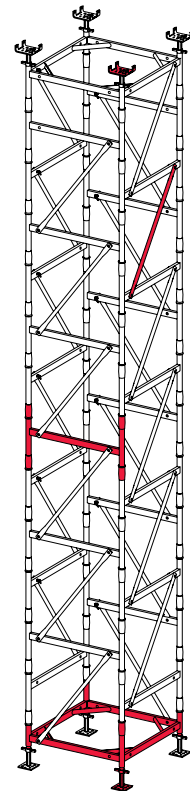

The ST 100 Stacking Tower at a glance

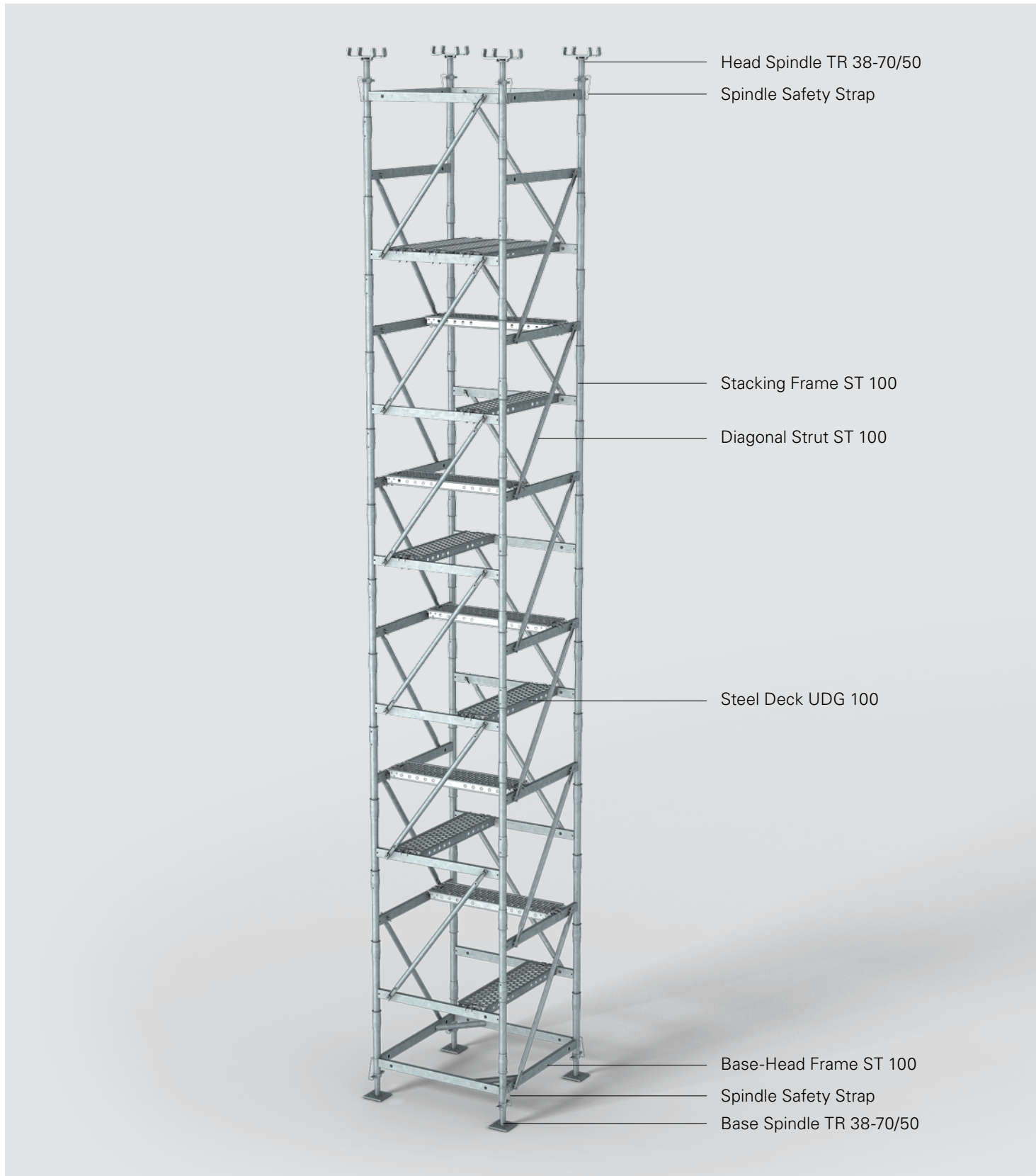

The PERI ST 100 is type tested. Expensive and time-consuming static calculations are therefore unnecessary. This type test is available from PERI at any time.



Execution details

Spindle

Crosshead Spindle for accommodating up to 2 GT 24 / VT 20 Formwork Girders

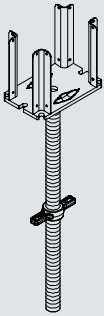

Almost any type of main beam, e.g. the GT 24 Girder, can be used with the head spindle.



The ST 100 Crosshead Spindle securely holds one or two GT 24 Girders so they cannot tilt.

Head Spindle for accommodating steel walers or other steel profiles. The maximum tilt of the forkhead is 4.4° on all sides.

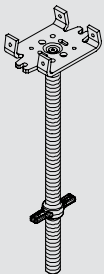

With large loads, the Head Spindle can accommodate standard PERI steel profiles, e.g. SRU or RCS profiles, as well as steel walers and other steel profiles.

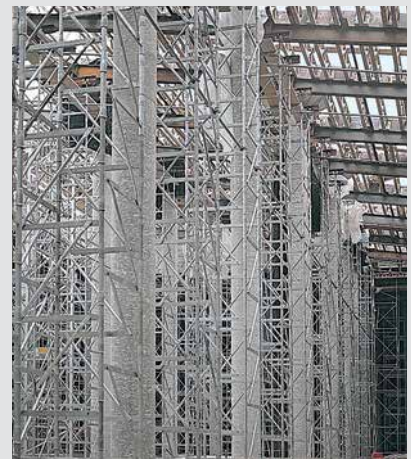

Lifting and moving

The ST 100 Stacking Tower can be moved by means of the Transportation Wheel UEW, or lifted and re-positioned with the crane.

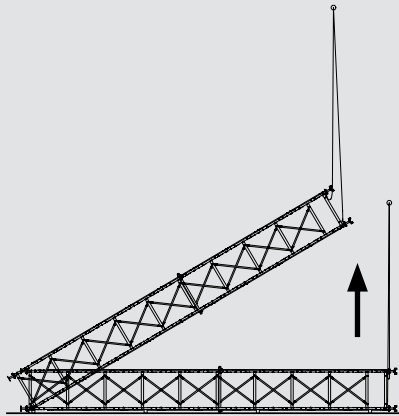

For all application variants, the following rule applies: whenever the tower is erected or moved with the crane, the Safety Strap Spindle is attached at the top and bottom.

Moving the towers by means of the Transportation Wheel UEW (with integrated Safety Strap Spindle) Permissible load-bearing capacity per wheel 3.5 kN with a spindle extension of the shoring tower of up to 30 cm.

Space-saving storage and transportation

PERI Pallets and Stacking Devices are suitable for lifting by crane or forklift. They can also be moved with the PERI Pallet Lifting Trolley. All pallets and stacking devices can be lifted using both the longitudinal and front sides.

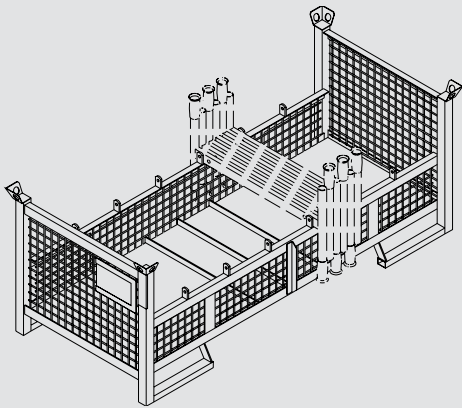
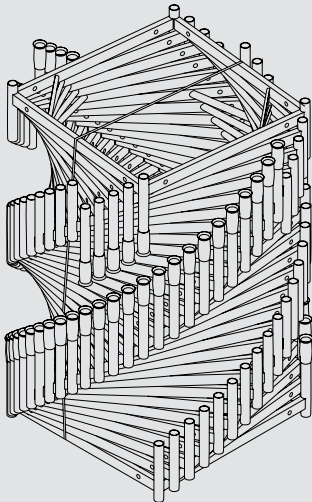

As a space-saving measure, the Base-Head Frame ST 100 can be stored and transported in stacks.

The Pallet ST 100 has the capacity to accommodate 84 Stacking Frames, Base and Head Spindles, and Diagonal Braces.

ST 100 Stacking Tower in use

Siekierkowska-Route Interchange, Warsaw, Poland

Not far from the Warsaw city centre, the well-known Siekierkowska route negotiates the Bora Komorowskiego road junction – on three levels and with no intersections – in the direction of the southern ring road using the two OE-1 and OE-2 bridge constructions. The access ramps, 723 m and 419 m respectively, run up to twelve metres above the ground level and what is now the current street level.

PERI Warsaw offered the most cost-effective solution for construction of both the piers and retaining walls, as well as the bridge superstructure. For forming the box-type cross-sections of the reinforced concrete bridges, PERI engineers designed framed formwork units on the basis of rentable standard components. The formwork units could be safely carried on MULTIPROP and ST 100 shoring constructions. The ST 100 Stacking Tower was quickly erected as parts were simply slotted together without requiring any bolts or pins. Lightweight individual components also ensured simple and fast assembly. The ST 100 is type-tested which means time-consuming static calculations are not required.



PERI framed formwork units were fixed to the bridge superstructure. In so doing, the shoring construction could then be sectionally dismantled for the next cycle.

Belchatow Power Plant, Poland

For the sorption facility, a reinforced concrete structure with two levels at heights of 12 m and 25 m was created. Slab thicknesses were 25 cm and 80 cm with downstand beam heights of 2.20 m to 3.20 m. Four huge reinforced concrete rings, each with a 6 m internal radius and 3 m to 4 m high, were integrated in the top slab to accommodate the 55 m high steel silos.

The shoring combination was comprised of ST 100 Stacking Towers as well as towers comprised of MULTIPROP aluminium slab props connected with MRK frames. Supported by ST 100 Stacking Towers, the loads from the over 25 m high partially cantilevered slabs could be safely transferred to the ground. PERI engineers positioned the MULTIPROP and ST 100 for the upper level on a girder grid. This was formed from HDT main beams from the HD 200 heavy-duty system. As a result, optimal load distribution was achieved on the beams of the 25 cm thick intermediate slab thus avoiding the need for any temporary supports involving plenty of material, time and costs.



The modular MULTIPROP system and ST 100 Stacking Towers, ideally combined. Rentable SRZ and SRU Steel Walers from the VARIO wall formwork product range were used for load distribution.



KVMRT Package V3, Bandar Utama, Malaysia

ST 100 Stacking Tower



Item no.	Weight kg
019900	16.600

Base-Head Frame ST 100, galv.

Base and head frame for the ST 100 Stacking Tower.

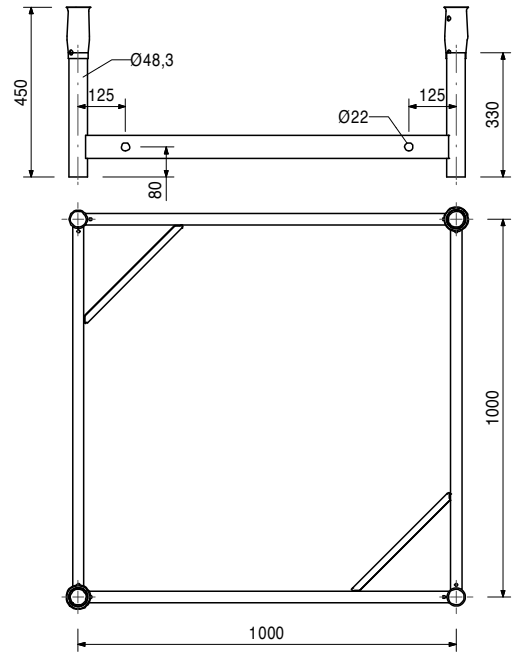
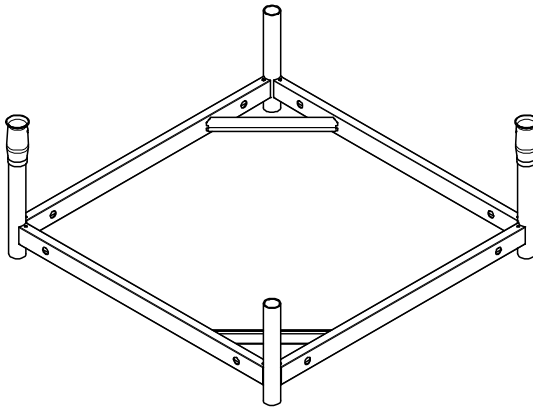

019910	6.820
--------	-------

Stacking Frame ST 100, galv.

Frame for Stacking Tower ST 100. 4 pieces per ascending metre.

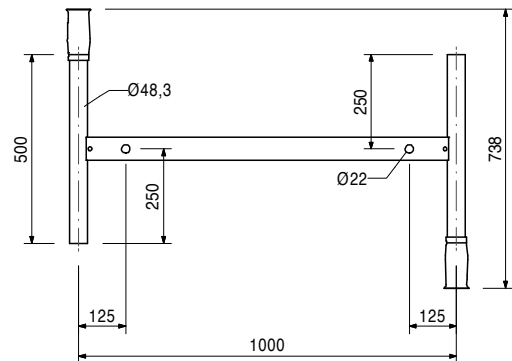
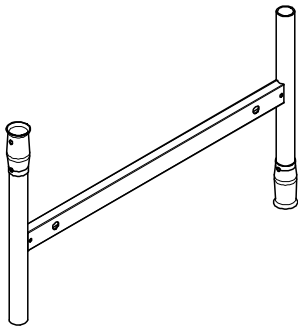

019940	2.270
--------	-------

Diagonal Strut ST 100, galv.

Diagonals for Stacking Tower ST 100. Number required depends on the static system.

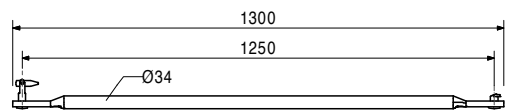
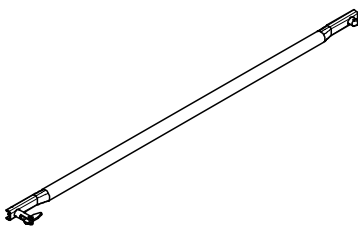

ST 100 Stacking Tower



Item no.	Weight kg
019780	5.250

Base Spindle TR 38-70/50
For heavily loaded shoring.

Note
With captive silver Quick Jack Nut.

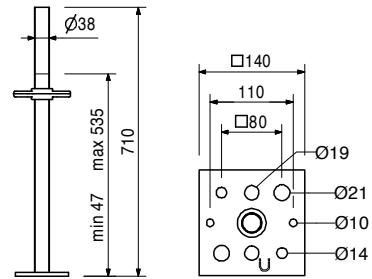
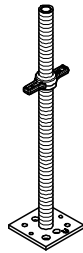

019950	7.770
--------	-------

Cross Forkhead TR 38-70/50
Tilt-resistant head spindle for holding one or two GT 24 or VT 20 Girders.

Note
With captive Quick Jack Nut.

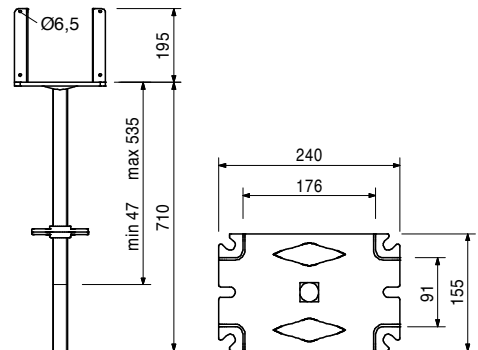
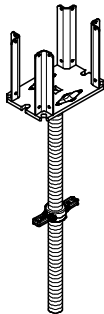

Accessories

028590	0.568
--------	-------

Tension Strap 16-25, galv.

116081	7.040
--------	-------

Head Spindle-2 TR 38-70/50
Maximum inclination of the head plate on all sides 4.4°.

Note
With locking device and captive Quick Jack Nut.

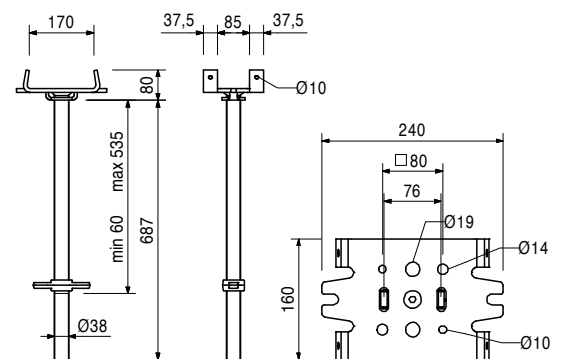
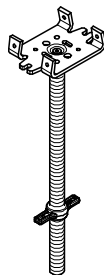

Accessories

028590	0.568
018300	0.564

Tension Strap 16-25, galv.
Cross Strap, galv.

ST 100 Stacking Tower

Item no.	Weight kg
028590	0.568

Tension Strap 16-25, galv.

For mounting 2 GT 24 or VT 20 Girders on the Cross Forkhead and Head Spindle TR 38 and on the Crosshead 20/24 or 20/24S.

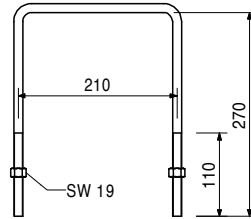
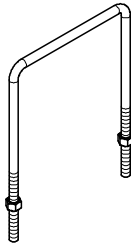

018300	0.564
--------	-------

Cross Strap, galv.

For fixing Steel Walers SRZ and SRU on the Head Spindle TR 38.

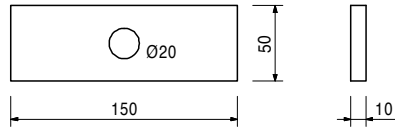
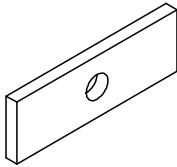

Accessories

018350	0.310
--------	-------

Bolt ISO 4016 M16 x 160-4.6 MU, galv.

019800	0.063
--------	-------

Spindle Safety Strap ST 100

To prevent spindles from falling out during moving with the crane.

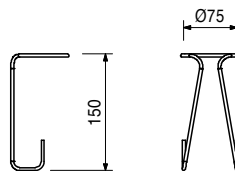

ST 100 Stacking Tower

Item no.	Weight kg		L	X
114613	1.420	Ledgers UH Plus	204	250
125840	1.770	Ledger UH 25 Plus	329	375
114595	2.070	Ledger UH 37.5 Plus	454	500
114629	2.730	Ledger UH 50 Plus	704	750
114632	4.390	Ledger UH 100 Plus	954	1000
114638	5.340	Ledger UH 125 Plus	1204	1250
114641	4.710	Ledger UH 150 Plus	1454	1500
117032	5.380	Ledger UH 175 Plus	1704	1750
114645	6.040	Ledger UH 200 Plus	1954	2000
116356	6.700	Ledger UH 225 Plus	2204	2250
114648	7.360	Ledger UH 250 Plus	2454	2500
114651	8.680	Ledger UH 300 Plus	2954	3000

Note
 Longitudinally-stamped for easier identification.

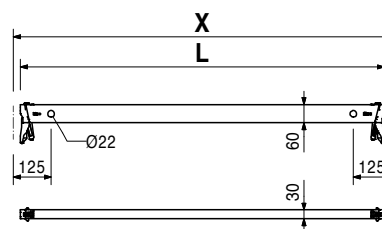
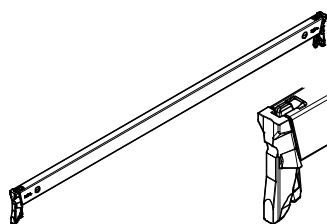

124118	6.630	Steel Deck UDG 25 x 100 Mounted on Ledger UH.	X	perm. p [kN/m ²]	max. p [kN/m ²]
			1000	6.0	40.0

Note
 perm. p according to DIN EN 12811-1.
 max. p = maximum possible load without deflection limitation.

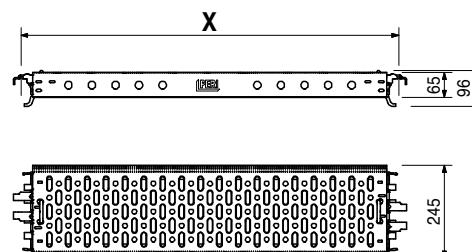
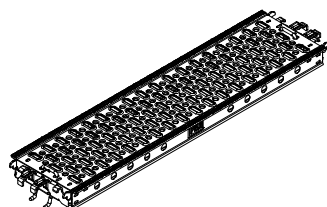

ST 100 Stacking Tower



Item no.	Weight kg
116176	15.000

Transportation Wheel UEW

For inserting in Connection Transportation Wheel UER (for Rosett) and Transportation Wheel ST 100.

Technical Data

Permissible load-bearing capacity 3.5 kN per wheel with spindle extension of Shoring Tower up to 30 cm.

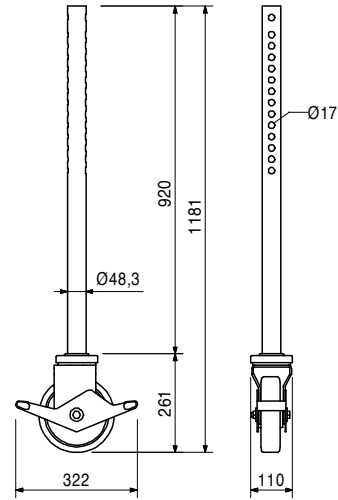
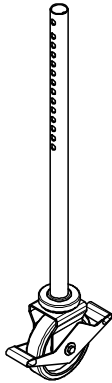

Accessories

116800	8.430
--------	-------

Connection Transportation Wheel ST 100

116800	8.430
--------	-------

Connection Transportation Wheel ST 100

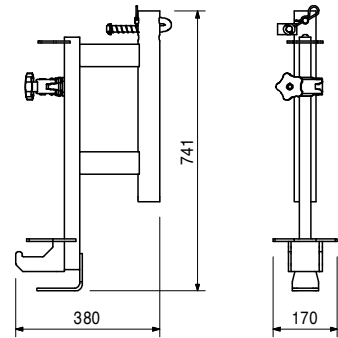
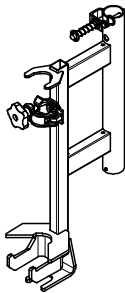

116306	1.700
--------	-------

Rosett Coupler UEV 180°

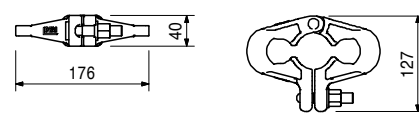
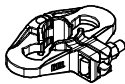

ST 100 Stacking Tower

Item no.	Weight kg
065050	129.000

Pallet ST 100/2, galv.

For stacking and transportation of ST 100.
Capacity: 84 stacking frames + base and head
spindles + diagonals.

Note

Follow Instructions for Use!

Technical Data

Permissible load-bearing capacity 1.5 t.

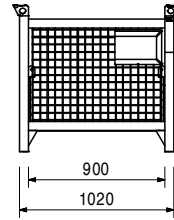
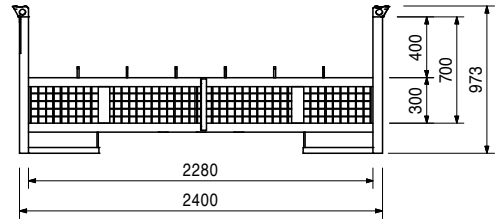
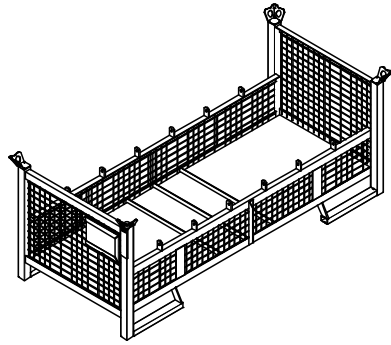

**The optimal System
for every Project and
every Requirement**



Wall Formwork



Column Formwork



Slab Formwork



Climbing Systems



Bridge Formwork



Tunnel Formwork



Shoring Systems



Construction Scaffold



Facade Scaffold



Industrial Scaffold



Access



Protection Scaffold



Safety Systems



System-Independent Accessories



Services



PERI GmbH
Formwork Scaffolding Engineering
 Rudolf-Diesel-Strasse 19
 89264 Weissenhorn
 Germany
 Tel. +49 (0) 7309.950-0
 Fax +49 (0) 7309.951-0
 info@peri.com
 www.peri.com